

elebia®

smart lifting solutions



elebia®

smart lifting solutions



elebia will boost the safety and productivity of your cranes

elebia, the unique automatic hook that allows you to attach and release the load remotely

1.

the magnet attracts the ring...



2.

...adjusts the lifting hook...



3.

...and elevates the load

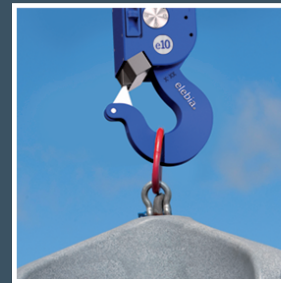

The patented elebia automatic hook is equipped with a magnet in its lower section. When the magnet is close to the load, it attracts and correctly positions the sling. The operator pushes the control button, the safety hook closes, catches the ring and lifts the load without any additional handling. The lifting hook works with cable slings, chains slings, master links, textile slings and even big bags. With the unique elebia automatic crane hook, you will be able to pick up and release loads remotely, avoiding any handling and moving, minimising risks, enhancing safety and increasing productivity.

elebia, the automatic hook of the future



AUTOMATIC HOOKS

evo2 MAIN FEATURES



Small, Compact, Light & Tough

We have created an automatic hook that is lighter, smaller and more compact but equally as strong.

Top Link

The system that links the automatic hook with the crane can be customized in order to adapt itself to any kind of situation.

Swivel with Bearings

The bearings allow the hook to rotate freely.

Swivel with Lock

The operator can lock it at every 90° position.

Efficient

3 hour charge - 5,000 cycles / 250 hours in standby mode.
With the new Eink charge status display system and new electronics, autonomy and consumption are optimized.

Clutch Protected

Motor protected by slip clutch.

Automatic Latch

The latch retracts automatically while the hook opens. This way, it remains hidden and protected.

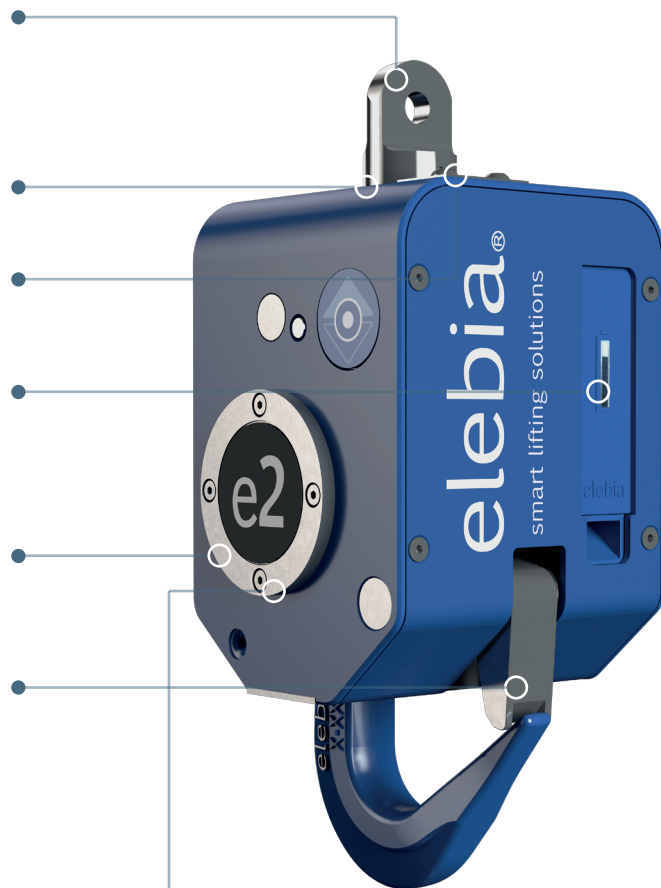

POSITION ENCODER

The evo2 incorporates an innovative position encoder. This allows the user to know the exact position of the hook, allowing better control. This results in longer motor life and safer operations.

The sensor is contactless: No wearings and zero maintenance.

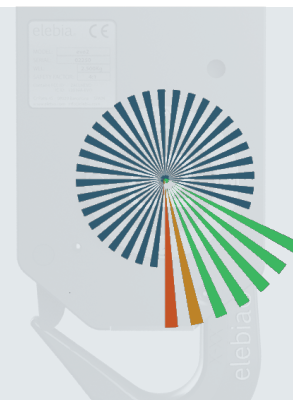

AUTOMATIC HOOKS

evo5 to evo25 MAIN FEATURES



- Swivel with bearings
If required, the swivel can be set in a fixed position (optional)
- Ready to be upgraded with weighing scale
- Removable and rechargeable lithium battery with LED charge indicator and locking system
- Clutch protected electric motor
- WELDOX® high strength structural steel body
- Manual operation button
- Impact and corrosion resistant polyester coating
If required, coating for marine environments is available (optional)
- elebia magnetic field generator
If required, sensor will indicate when ring is in position (optional)
- Spring-operated stainless steel safety latch
- Forged hook

The innovative position encoder has been integrated into the evo10, evo10c, evo20 and evo25 lifting hooks.

(This feature is optional for the evo5 automatic hook).



HOOK MODEL

evo2

evo5

WORKING LOAD LIMIT

SAFETY FACTOR 4:1

TOP LINK OPTION*

2,500 kg / 5,511 lb

5,000 kg / 11,023 lb

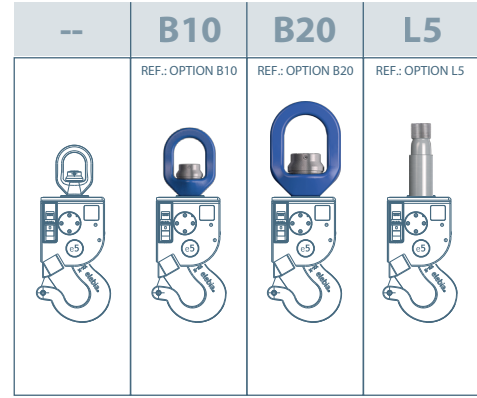
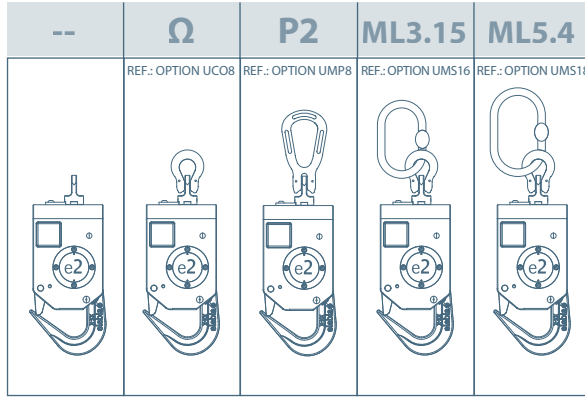

* go to page 20 for more details on Top Link options

WEIGHT

7 kg 15.43 lb	7.2 kg 15.87 lb	7.3 kg 16.09 lb	8.5 kg 18.74 lb	9.5 kg 20.94 lb
------------------	--------------------	--------------------	--------------------	--------------------

26 kg 57.32 lb	31 kg 68.34 lb	38 kg 83.77 lb	---*
-------------------	-------------------	-------------------	------

SIZE CHART

mm / in

A	188 / 7.40	188 / 7.40	188 / 7.40	188 / 7.40	188 / 7.40
B	131.5 / 5.18	131.5 / 5.18	131.5 / 5.18	131.5 / 5.18	131.5 / 5.18
C	269.3 / 10.60	269.3 / 10.60	269.3 / 10.60	269.3 / 10.60	269.3 / 10.60
D	22 / 0.87	22 / 0.87	22 / 0.87	22 / 0.87	22 / 0.87
E	120.9 / 4.76	120.9 / 4.76	120.9 / 4.76	120.9 / 4.76	120.9 / 4.76
F	42.5 / 1.67	42.5 / 1.67	42.5 / 1.67	42.5 / 1.67	42.5 / 1.67
G	28.8 / 1.13	28.8 / 1.13	28.8 / 1.13	28.8 / 1.13	28.8 / 1.13
H	26.7 / 1.05	26.7 / 1.05	26.7 / 1.05	26.7 / 1.05	26.7 / 1.05
I	21.3 / 0.84	21.3 / 0.84	21.3 / 0.84	21.3 / 0.84	21.3 / 0.84
J	11 / 0.43	11 / 0.43	11 / 0.43	11 / 0.43	11 / 0.43
K	- / -	55 / 2.16	111 / 4.37	- / -	- / -
L	- / -	23.5 / 0.92	- / -	- / -	- / -

*L Size is on demand

M	277 / 10.91	277 / 10.91	277 / 10.91	277 / 10.91
N	170 / 6.69	170 / 6.69	170 / 6.69	170 / 6.69
O	469 / 18.46	519.8 / 20.46	598.9 / 23.58	CUSTOM
P	409 / 16.10	451.3 / 17.76	519.5 / 20.45	CUSTOM
Q	194 / 7.64	194 / 7.64	194 / 7.64	194 / 7.64
R	43 / 1.70	43 / 1.70	43 / 1.70	43 / 1.70
S	49 / 1.93	68 / 2.68	105 / 4.13	CUSTOM
T	57.6 / 2.26	57.6 / 2.26	57.6 / 2.26	57.6 / 2.26
U	25 / 0.98	25 / 0.98	25 / 0.98	25 / 0.98
V	41 / 1.61	41 / 1.61	41 / 1.61	41 / 1.61
W	58 / 2.28	82 / 3.23	115 / 4.53	CUSTOM
X	350 / 13.78	400.4 / 15.76	480 / 18.87	CUSTOM
Y	15 / 0.59	22 / 0.87	29 / 1.14	CUSTOM

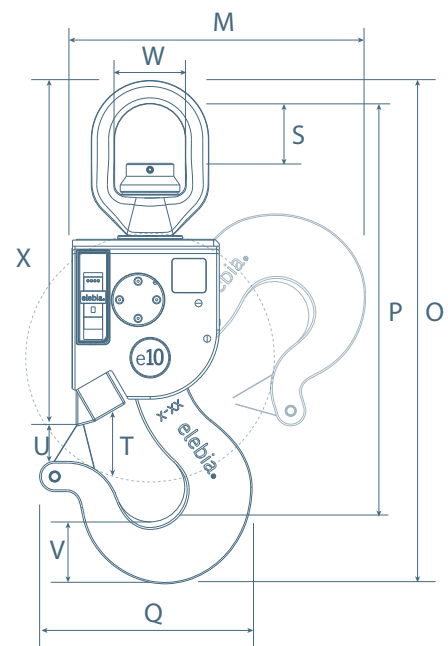
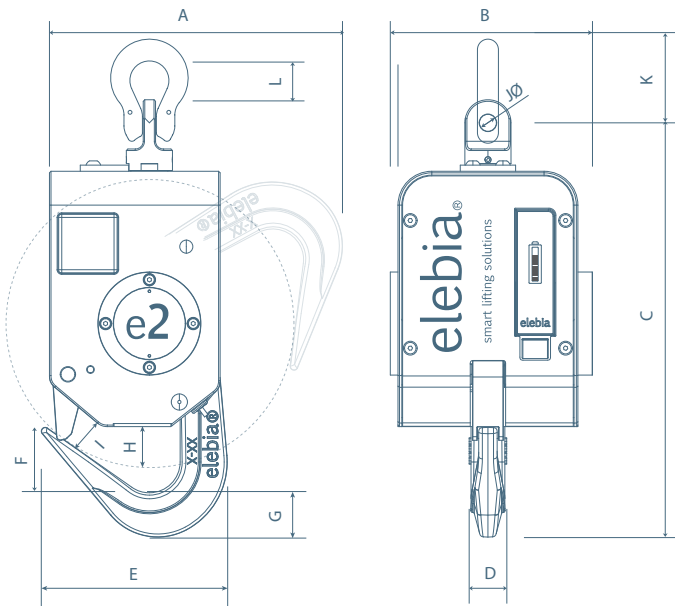

evo10c

10,000 kg / 22,046 lb

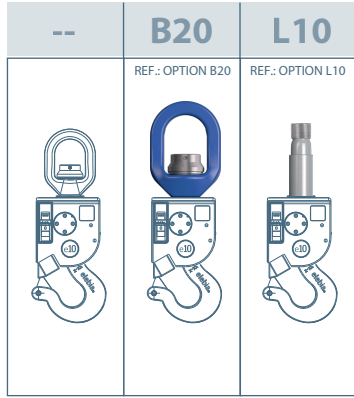

31 kg / 68.34 lb 38 kg / 83.77 lb ---*

evo10

10,000 kg / 22,046 lb

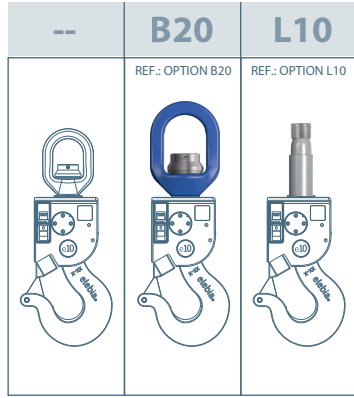

36 kg / 79.36 lb 43 kg / 94.79 lb ---*

evo20

20,000 kg / 44,092 lb

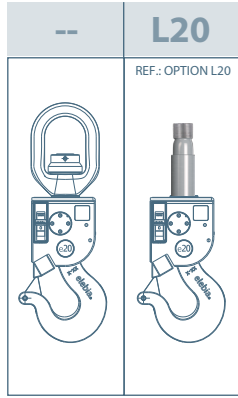

43 kg / 94.79 lb ---*

evo25

25,000 kg / 55,115 lb

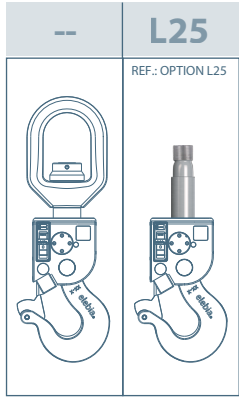

48 kg / 105.82 lb ---*

*L Size is on demand

277 / 10.91	277 / 10.91	277 / 10.91
170 / 6.69	170 / 6.69	170 / 6.69
519.8 / 20.46	598.9 / 23.58	CUSTOM
451.3 / 17.76	519.5 / 20.45	CUSTOM
194 / 7.64	194 / 7.64	194 / 7.64
43 / 1.70	43 / 1.70	43 / 1.70
68 / 2.68	105 / 4.13	CUSTOM
57.6 / 2.26	57.6 / 2.26	57.6 / 2.26
25 / 0.98	25 / 0.98	25 / 0.98
41 / 1.61	41 / 1.61	41 / 1.61
82 / 3.23	115 / 4.53	CUSTOM
400.4 / 15.76	480 / 18.87	CUSTOM
22 / 0.87	29 / 1.14	CUSTOM

*L Size is on demand

342 / 13.46	342 / 13.46	342 / 13.46
182.3 / 7.18	182.3 / 7.18	182.3 / 7.18
584 / 23.99	663 / 26.10	CUSTOM
485 / 19.10	553 / 21.77	CUSTOM
246 / 9.68	246 / 9.68	246 / 9.68
66 / 2.60	66 / 2.60	66 / 2.60
68 / 2.68	105 / 4.13	CUSTOM
83 / 3.27	83 / 3.27	83 / 3.27
42 / 1.65	42 / 1.65	42 / 1.65
72 / 2.83	72 / 2.83	72 / 2.83
82 / 3.23	115 / 4.53	CUSTOM
400.4 / 15.76	480 / 18.90	CUSTOM
22 / 0.87	29 / 1.14	CUSTOM

*L Size is on demand

341 / 13.43	341 / 13.43
182.3 / 7.18	182.3 / 7.18
663 / 26.10	CUSTOM
553 / 21.77	CUSTOM
246 / 9.68	246 / 9.68
66 / 2.60	66 / 2.60
105 / 4.13	CUSTOM
83 / 3.27	83 / 3.27
42 / 1.65	42 / 1.65
72 / 2.83	72 / 2.83
115 / 4.53	CUSTOM
480 / 18.90	CUSTOM
29 / 1.14	CUSTOM

*L Size is on demand

341 / 13.43	341 / 13.43
182.3 / 7.18	182.3 / 7.18
735 / 28.94	CUSTOM
618 / 24.33	CUSTOM
246 / 9.68	246 / 9.68
66 / 2.60	66 / 2.60
138.5 / 5.45	CUSTOM
83 / 3.27	83 / 3.27
42 / 1.65	42 / 1.65
72 / 2.83	72 / 2.83
133 / 5.24	CUSTOM
550 / 21.65	CUSTOM
34 / 1.34	CUSTOM

M
N
O
P
Q
R
S
T
U
V
W
X
Y



REGULATORY STANDARDS | evo2 to evo25



- EN 10204 3.1.B
 - UNE-EN 1050
 - UNE-EN 1677-1:2001+A1:2009
 - UNE-EN 1677-2:2001+A1:2008
 - Directive on machine safety. (D2006/42/EC)
 - Assurance of production quality in accordance with ISO 9001.
 - DNV 2.22 Certified (evo5 / evo10 / evo20)
 - Each mechanism is delivered with the CE stamp and a declaration of CE conformity.
 - elebia® is a member of F.E.M. (European Federation of Materials Handling)
 - 100% of the hooks are load tested at 125% WLL and magnetic particles inspected.
- UNE-EN 60204-1:2007
 - UNE-EN 61000-6-4:2007
 - UNE-EN 61000-6-2:2006
 - UNE-EN ISO 12100:2012
- D89/391/EEC
 - D89/654/EEC
 - D89/655/EEC
 - D89/656/EEC
 - D92/58/EEC 9a

HOW DOES IT WORK?

The automatic safety hook lifts and releases the load remotely. The remote crane hook generates a magnetic field that attracts and orients the sling, masterlink or rigging gear. The operator then presses the “close” button on the remote control to automatically close the hook, without any manual intervention, operating remotely from a safe distance, minimising risks, enhancing safety and increasing productivity.



SMART	EFFICIENT	POWERFUL	TOUGH
 <p>A sensor in the magnet indicates when the ring is in position. All this information is recorded in the eMAX remote control that acts as a hub gathering all the information and recording all the activity of the hook.</p>	 <p>We've redesigned the high capacity battery to improve efficiency and minimise energy consumption of the automatic hook. The battery is fully charged in 3 hours, and allows up to 5,000 cycles or 250 hours in standby mode.</p>	 <p>The new gearmotor allows you to release up to 20 kg / 44.09 lb. There will be no more problems with heavy rigging and with the precise electronic torque control, you can adjust the release limit. It is also clutch protected from overloads.</p>	 <p>Designed to work in the toughest conditions (steelworks, ports, low temperatures) and built with the best materials. WELDOX high strength structural steel body. Class T and class V forged hook.</p>

WELDOX®
HIGH STRENGTH STEEL

MAGNETIC SYSTEM

The elebia automatic hooks are designed with a unique magnetic system, formed by 32 neodymium permanent magnets placed in a precise configuration that generate an oriented magnetic field with 3 functions: attract, center and orient the masterlink. This basic component, which is present in all our automatic hooks, is what allows the remote engage of any load.

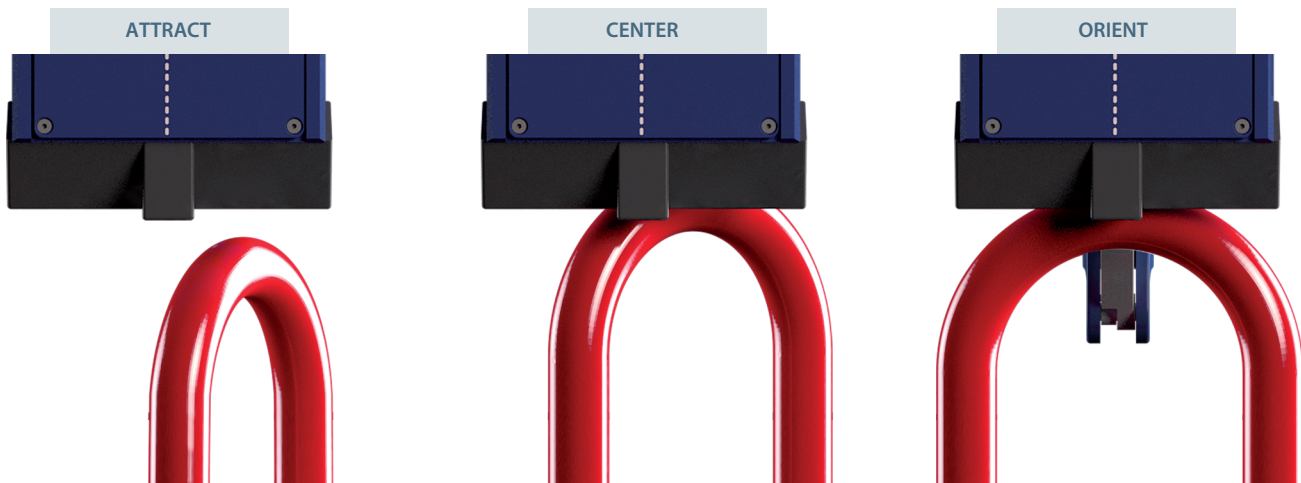

Other setting options are also available

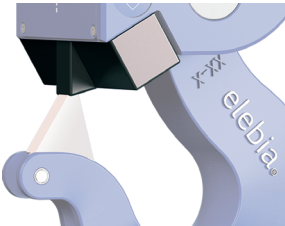
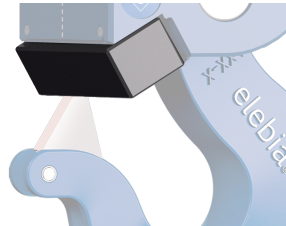
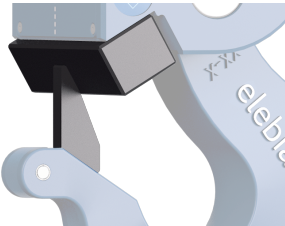
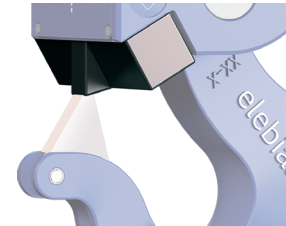
MAGNET SENSOR <small>REF.: OPTION S</small>	POWER MAGNET <small>REF.: OPTION PM</small> <small>(Not available for evo2)</small>	POWER MAGNET & RIGID SAFETY LATCH <small>REF.: OPTION PMA</small> <small>(Not available for evo2)</small>	VOID, NO MAGNETS <small>REF.: OPTION V</small>
 <p>DESCRIPTION A sensor in the magnet indicates when the masterlink is attached to it. This info is displayed in the eMAX remote control. Units with the magnet sensor can be configured in 'Autoclose Mode': the hook will automatically close when the magnet sensor detects the ring is in position. The magnet sensor's sensitivity/trigger level can be adjusted to customer needs.</p> <p>RECOMMENDED FOR Applications where it is difficult to see the lifting point. Automated processes, as the magnet sensor info can be used by the PLC controlling the crane.</p>	 <p>DESCRIPTION Increased magnetic power.</p> <p>RECOMMENDED FOR Applications where the lifting point is weakly attracted by the magnet (some stainless steels). Applications where the hook is below a long wire rope, and a lot of swinging makes it difficult to catch the masterlink.</p>	 <p>DESCRIPTION Instead of the standard safety latch (movable, spring loaded), this is a fixed latch, forming a complete closed loop along with the automatic hook.</p> <p>RECOMMENDED FOR Applications where the lifting points are fixed rings (eyebolts, handles, etc.)</p>	 <p>DESCRIPTION No magnetic system.</p> <p>RECOMMENDED FOR Applications where only a remote release is needed.</p>

FAIL-SAFE DESIGN

The elebia automatic hook was devised to enhance safety and increase productivity. It is designed under a fail-safe principle. The automatic hook CAN NOT drop a suspended load. This is a feature of all our designs, geometrically fail-safe, without any sensors or electric components.

To release the load, the motor must rotate or turn the hook, lifting the load contained therein. The motor's torque is not powerful enough to open the hook when a load is suspended. Gravity is what avoids the opening of the safety hook if there's a suspended load.

In addition, our automatic hooks incorporate a Security Torque Limit (STL). An electronic device that controls the motor's torque and cancels the operation if an overload is detected. If the order to open the hook is mistakenly sent while the load is suspended, the operation is interrupted and inverted (the hook closes automatically).

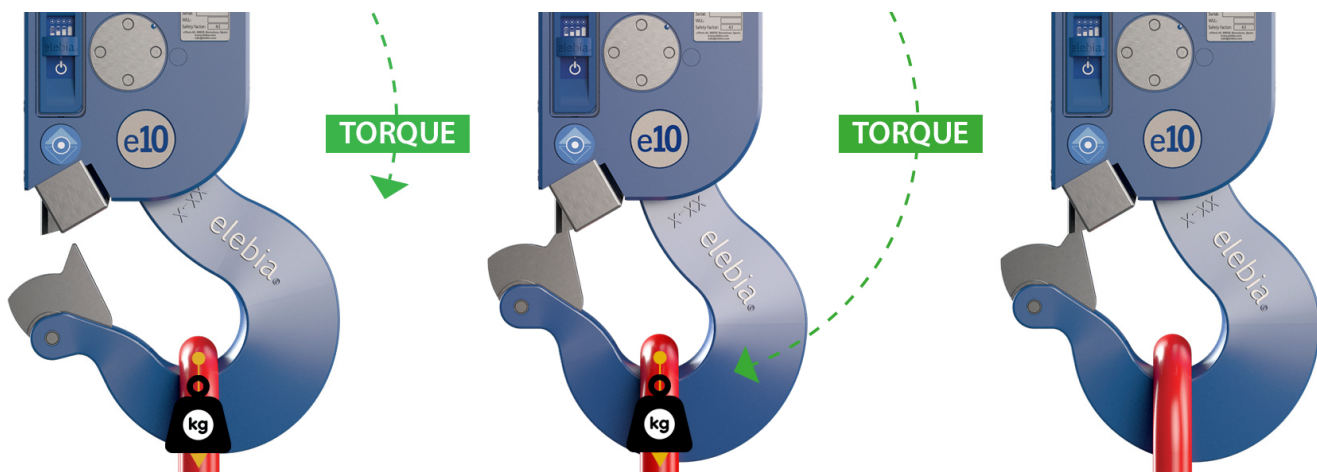

SAFETY LATCH

Another crucial security element of the hook is the safety latch. There are two options:

Spring Loaded Latch

Spring loaded latch which impedes the sling from accidentally unloading from the hook.



Rigid Safety Latch

This option is for more extreme operations (marine, offshore), where constant movement can contribute to the unloading of the slings from the hook if using the spring loaded latch.

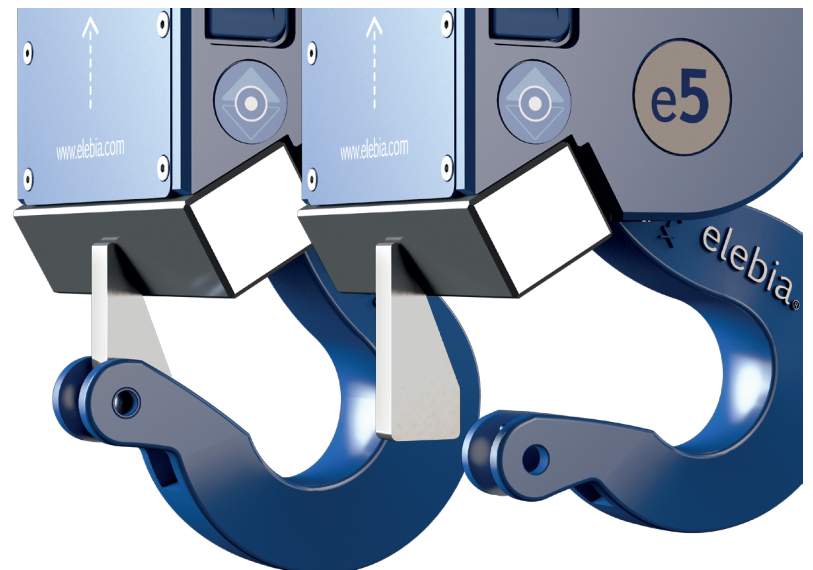

LOAD CELL / WEIGHING SCALE

DESCRIPTION:

The complete range of automatic hooks can be upgraded with a load cell to weigh the load that is being lifted. This load cell is precise, reliable, compact and fully integrated into the hook, representing no increase in weight or dimensions of the unit. The load cell is highly recommended for preventing overloads and for load control. Load cells can also be retrofitted into older models of our hooks.

The load cell in combination with the eMAX remote control transforms all of our hooks into a precise weighing scale with advanced features.

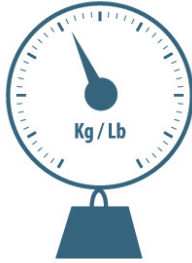

SPECIFICATIONS

Load Cell Type	Compression / flexion ring
Material	Stainless steel
Protection	IP67 (EN60529)
Nominal Capacities (Ln)	2,500
Precision Class	0.2
Minimum Dead Load	0
Service Load	120
Ultimate Load	500
Total Error	< ±0.2
Repeatability Error	< ±0.04
Temperature Effect:	
on zero	< ±0.01
on sensitivity	< ±0.01
Creep Error (30min)	< ±0.03
Temperature Compensation	-20 °C to 50 °C
Temperature Limits	-30 °C to 70 °C
Nominal Sensivity (Sn)	2 ±0.25%
Nominal Input Voltage	10
Maximum Input Voltage	15
Input Impedance	800 ±30
Output Impedance	700 ±5
No Load Input	< ±2
Insulation Resistance	>5,000
Maximum Deflection (at Ln)	0.4

evo2 REF.: OPTION LC2	evo5 REF.: OPTION LCS	evo10 REF.: OPTION LC10	evo20 REF.: OPTION LC20	evo25 REF.: OPTION LC25	
Compression / flexion ring	Compression / flexion ring	Compression / flexion ring	Traction	Traction	
Stainless steel	Stainless steel	Stainless steel	Stainless steel	Stainless steel	
IP67 (EN60529)	IP67 (EN60529)	IP67 (EN60529)	IP67 (EN60529)	IP67 (EN60529)	
2,500	5,000	10,000	20,000	25,000	Kg
0.2	0.2	0.2	0.2	0.2	%
0	0	0	0	0	%Ln
120	120	120	120	120	%Ln
500	500	500	400	400	%Ln
< ±0.2	< ±0.2	< ±0.2	< ±0.2	< ±0.2	%Sn
< ±0.04	< ±0.06	< ±0.08	< ±0.08	< ±0.08	%Sn
< ±0.01	< ±0.01	< ±0.01	< ±0.01	< ±0.01	%Sn / 5°K
< ±0.01	< ±0.01	< ±0.01	< ±0.01	< ±0.01	%Sn / 5°K
< ±0.03	< ±0.03	< ±0.03	< ±0.03	< ±0.03	%Sn
-20 °C to 50 °C	-20 °C to 50 °C	-20 °C to 50 °C	-20 °C to 50 °C	-20 °C to 50 °C	°C
-30 °C to 70 °C	-30 °C to 70 °C	-30 °C to 70 °C	-30 °C to 70 °C	-30 °C to 70 °C	°C
2 ±0.25%	2 ±0.25%	2 ±0.25%	1 ±0.25%	1 ±0.25%	mV/V
10	10	10	10	10	V
15	15	15	15	15	V
800 ±30	800 ±30	800 ±30	800 ±30	800 ±30	Ω
700 ±5	700 ±5	700 ±5	700 ±5	700 ±5	Ω
< ±2	< ±2	< ±2	< ±2	< ±2	%Sn
>5,000	>5,000	>5,000	>5,000	>5,000	MΩ
0.4	0.4	0.4	0.3	0.3	mm

SPECIAL ENVIRONMENTS

The standard automatic hook units are rugged, designed and built to work in almost every industry.

For special environments, you have the following options:

MARINE

REF.: OPTION M



CSM Painting and AISI components.

RECOMMENDED FOR

Marine Environments

INDUSTRIES

Offshore Wind Turbines, Onboard Cranes, Buoys



DNV

REF.: OPTION DNV



DNV 2.22 certification for Offshore lifting appliances.

RECOMMENDED FOR

Offshore Operations

INDUSTRIES

Offshore Wind Turbines, Onboard Cranes



ATEX / IECEx

REF.: OPTION EX



Units with IECEx certification for zones 1 & 21 according to European Directive 2014/34/EU and IECEx international standards. IECEx certification to work on sites classified as zone 1 & zone 21 according to the European Directive 99/92/EC and IECEx international standards.

RECOMMENDED FOR

Operations in potentially explosive atmospheres

INDUSTRIES

Oil & Gas, Mining & Chemical

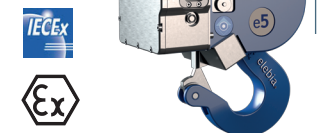

HEAT SHIELD

REF.: OPTION HS



Heat shield that protects the automatic hook and its electronic components from radiated heat and extended temperature working range.

RECOMMENDED FOR

Operations where the automatic hooks are subject to extremely elevated temperatures and radiated heat

INDUSTRIES

Foundries



REMOTE CONTROLS

MAIN FEATURES

elebia produces different remote controls tailored to customer needs.

All of them allow simple, flexible, precise and reliable control in a failsafe way.

One remote control can be paired with one automatic hook or many, and one automatic hook can be controlled by many remotes.

We call it: One to One / One to Many / Many to One



GENERAL SPECIFICATIONS



Available Code Combinations	65,536 different combinations
Detection of Errors in Transmission	2 CRC bytes + Forward Error Correction
Frequency Selection	1
Frequencies	868MHz/915MHz (custom frequency on demand)
Communication	Bidirectional return of receiver battery status
Certification Standards	EN 300 220 Telecommunications EN 301 489 Electromagnetic Compatibility EN 60730 Low Voltage

Radiated Power	under 5 dBm
Antenna	Printed circuit
Consumption at Rest	
/ Transmission Operation	5 uA / 20 mA
Working Temperature	-20 °C to 85 °C / -4 °F to 185 °F
Range	100 metres / 330 feet
(Range can be increased up to 650 metres / 2,132 feet)	

eMINI (REF.: eMINI)

The eMINI is a small and compact remote control. It can be integrated into a glove or used with a wrist band to wear it as a watch.
 With the eMINI remote control, the operator can open and close the automatic hook and control its battery level.
 The eMINI also informs of the hook's annual inspection and displays sensor information and maintenance messages.
 The eMINI is a small but powerful remote control for crane hooks, compatible with all cranes and other remotes.

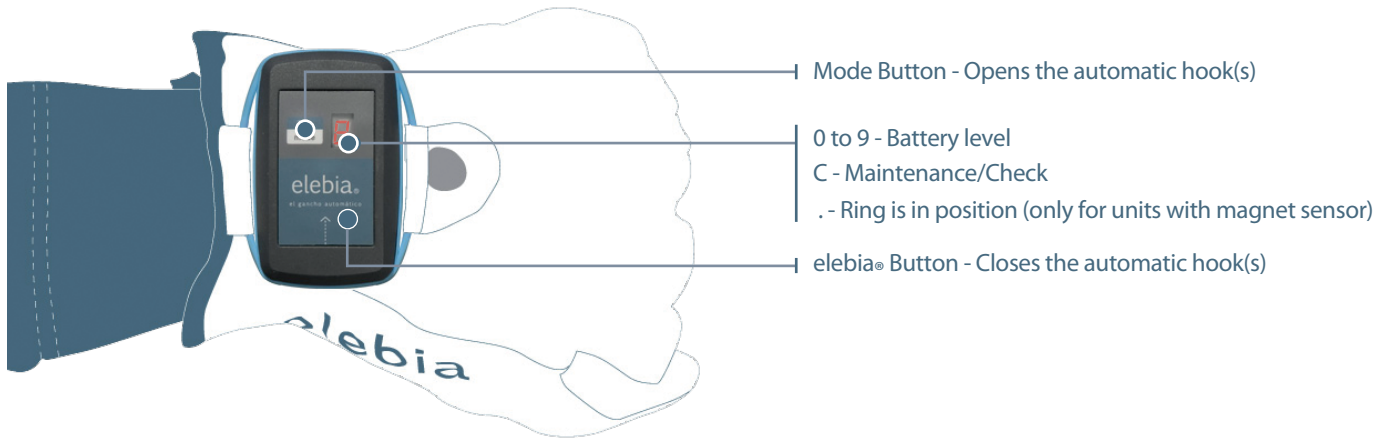

Power Supply	1 3V lithium battery (CR2032)
Autonomy	2 Years
Buttons	2
Dimensions	68 x 52 x 17 mm / 2.68 x 2.05 x 0.67 in

INSTALLABLE (REFS.: elnst24 / elnst48)

All elebia automatic hooks can also be controlled using a free channel of the crane's master control.
 The installable remote control simply has to be placed in the crane relay cabinet, where only a simple wiring is needed.
 Compatible with all cranes and other remotes.



Power Supply	24 V DC or 48 V DC
Buttons	2
Dimensions	80 x 140 x 45 mm / 3.15 x 5.51 x 1.77 in

The eMAX is our most advanced remote control, able to control the automatic hooks with load cell/weighing scale. It displays all the info in a big high-resolution screen and a high profile keypad, yet remains handy and lightweight.



- RS-232 serial port for PLCs (optional)
- Multifunctional USB port (can be used to charge the remote control, to export registered data and to update software)
- Real time input & output data/orders transmission
- Rugged enclosure, IP65
- Rubber bumper that protects the remote control against impacts
- Full colour, high-resolution TFT display
- Membrane keypad (can be operated with gloves)
- Directional keypad for fast, intuitive and user friendly navigation
- Vibration
- Buzzer
- Rechargeable Li-Ion battery

DISPLAY

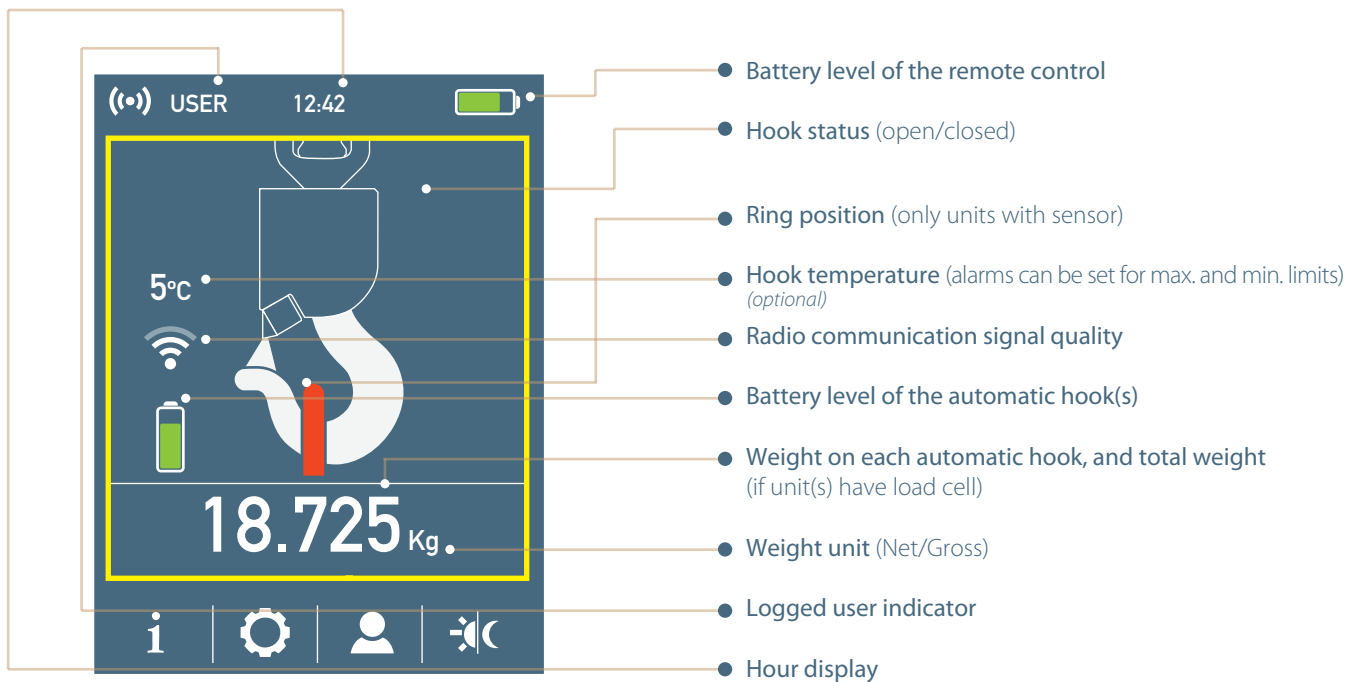

- Battery level of the remote control
- Hook status (open/closed)
- Ring position (only units with sensor)
- Hook temperature (alarms can be set for max. and min. limits) (optional)
- Radio communication signal quality
- Battery level of the automatic hook(s)
- Weight on each automatic hook, and total weight (if unit(s) have load cell)
- Weight unit (Net/Gross)
- Logged user indicator
- Hour display

Calcul de Regimen Alimentari (Alim)

date	ti
1	15/05/2014
2	15/05/2014
3	15/05/2014
4	15/05/2014
5	15/05/2014
6	15/05/2014
7	15/05/2014
8	19/05/2014
9	19/05/2014
10	19/05/2014
11	19/05/2014
12	19/05/2014
13	19/05/2014
14	20/05/2014
15	20/05/2014
16	20/05/2014
17	20/05/2014
18	20/05/2014
19	20/05/2014
20	20/05/2014
21	20/05/2014
22	20/05/2014
23	20/05/2014
24	20/05/2014
25	20/05/2014
26	23/05/2014
27	23/05/2014
28	23/05/2014
29	23/05/2014
30	23/05/2014
31	23/05/2014
32	23/05/2014
33	03/06/2014
34	03/06/2014
35	03/06/2014
36	03/06/2014

The eMAX remote control can manage and display up to 24 automatic hooks simultaneously. The high resolution display adapts itself and all the data to the number of automatic hooks in use.

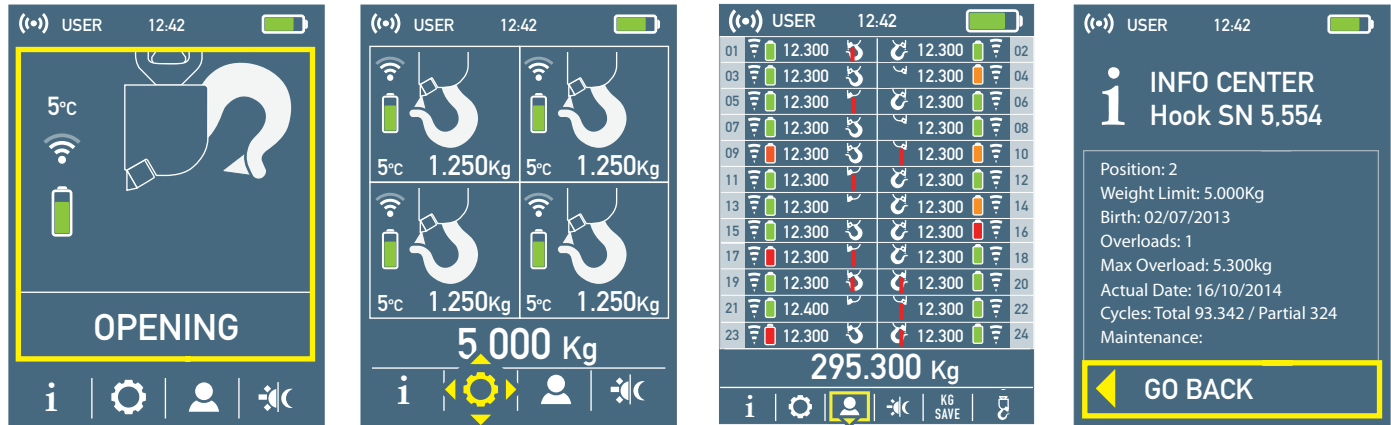

eMAX remote control with load cell

The load cell in combination with the eMAX remote control transforms all of our safety hooks into a precise weighing scale with advanced features.

- Capture weight
- Preset tares or capture tare
- Alarm in case of overload
(visual, buzzer and vibration. Info of overload value, user, date and time recorded into the log file).
- Alarm in case of unbalance
(when 2 or more automatic hooks are in use).
- Log events file with real time clock
(open, close, load, overload alarm, maintenance)
- Export log file via USB to spreadsheet

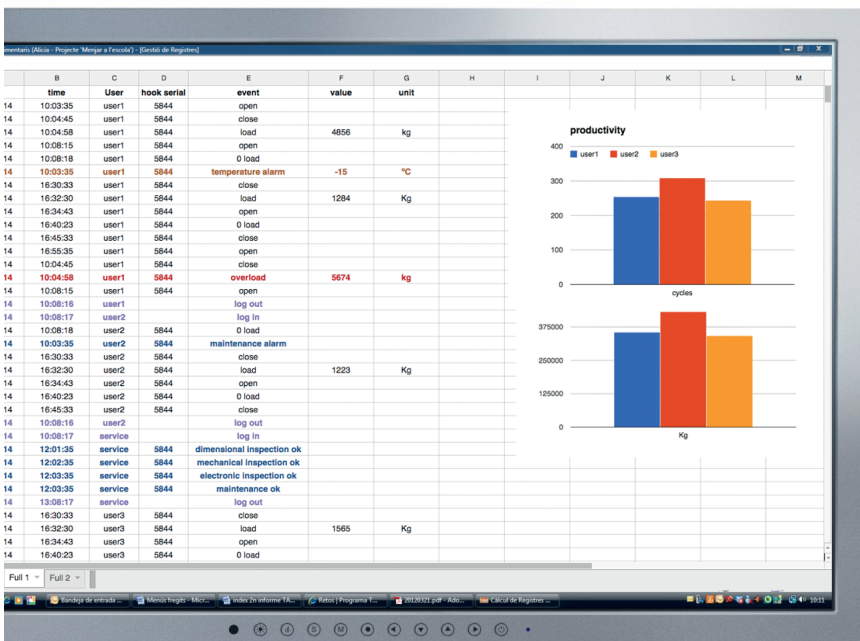

SPECIFICATIONS

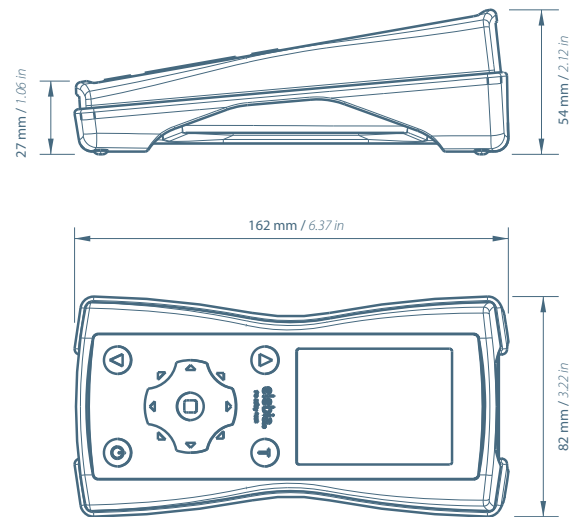

Weight: 200 g / 7.05 oz

BATTERY / CHARGERS

evo5 to evo25

BATTERY (REF.: evo 1700)



- Lock system
- LED charge indicator
- On/Off

No connectors. No wires. No cover. Push to insert. Pull to remove. Simple. Lock system to prevent the battery from falling in case of impact. ON/OFF button. Ergonomic rubber handle to pull and carry the battery. You'll always know the level of the battery thanks to 4 high brightness LEDs. Save battery when the automatic hook is not in use. High capacity: 3 hour charge - 5,000 cycles / 250 hours in standby mode.

Technology	Rechargeable Li-Ion
Maximum Voltage	24.8 V DC
Nominal Voltage	22.2 V DC
Nominal Capacity	2.6 Ah DC
Protection Circuit	Charge, Discharge, Overvoltage
Maximum Discharge Current	6 A
Heat Protection	Thermal 70 °C / 158 °F
Charge Indicator	Display ON 4 LED (25% - 50% - 75% - 100%)
Temperature (Charge)	0 °C to 45 °C / 32 °F to 113 °F
Temperature (Discharge)	-20 °C to 50 °C / -4 °F to 122 °F
Temperature (Idle)	-20 °C to 60 °C / -4 °F to 140 °F
Weight	390 g / 13.75 oz

220V Charger / 24V Charger (REF.: ch220)

Specifications	Technical Specifications
Input voltage	100-240 V AC / 50-60Hz 0.15A (max.)
Output	25.2 V DC / 1A
Charge indicator	Yes, by red LED
Charge complete indicator	Yes, by green LED

24V Charger

A 24V charger is also available.
The 24V charger should be used only in vehicles with a 24 volt connector.

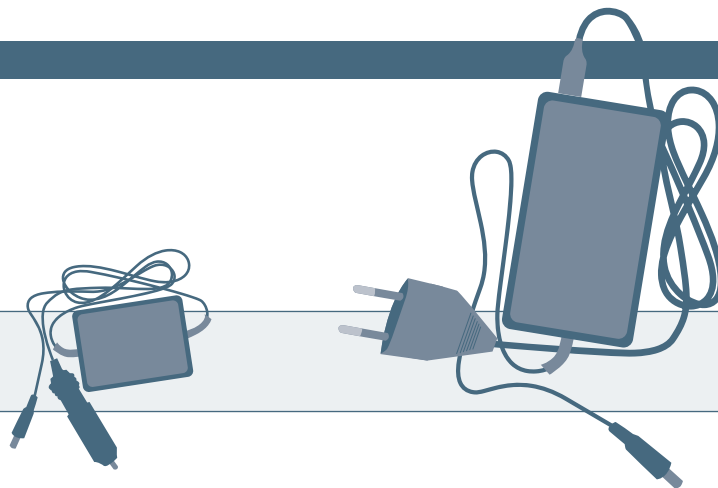

Multiple Charger (REF.: chx10)



A charging station for 10 batteries is also available. Set in a rigid flight case, with a handle for transportation. Keep everything tidy and ready to work.

Technical Specifications	
Dimensions	655 x 305 x 230 mm / 25.78 x 12.01 x
Input voltage	100-240 V AC / 50-60Hz 0.15A (max)
Charge indicator	Yes, by red LED
Charge complete indicator	Yes, by green LED
Main switch	
Charging indicator	

BATTERY / CHARGER

evo2

evo2 BATTERY (REF.: evo2 1700)

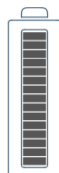

With the new E-ink charge status display system and new electronics, autonomy and consumption are optimized.
Save battery when the automatic hook is not in use.
High capacity: 3 hour charge - 5,000 cycles / 250 hours in standby mode.

Technology	Rechargeable Li-Ion
Maximum Voltage	12.4 V DC
Nominal Voltage	10.95 V DC
Nominal Capacity	3.2 Ah DC
Protection Circuit	Charge, Discharge, Overvoltage
Maximum Discharge Current	6.4 A
Heat Protection	Thermal 70 °C / 158 °F
Charge Indicator	E-ink 14 Segment Display
Temperature (Charge)	0 °C to 45 °C / 32 °F to 113 °F
Temperature (Discharge)	-20 °C to 50 °C / -4 °F to 122 °F
Temperature (Idle)	-20 °C to 60 °C / -4 °F to 140 °F
Weight	150 g / 5.29 oz

evo2 220V Charger (REF.: ch220 evo2)

Specifications	Technical Specifications
Input voltage	100-240 V AC / 50-60Hz 1.0A (max.)
Output	12.6 V DC / 1.2A
Charge indicator	No
Charge complete indicator	No

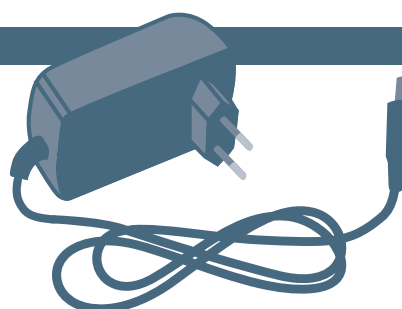

Multiple Charger (REF.: chx10 evo2)



Charging station for up to ten evo2 batteries.
Rigid flight case with handle for easy transportation.

Technical Specifications	
Dimensions	655 x 305 x 230 mm / 25.78 x 12.01 x 9.05 in
Input voltage	100-240 V AC / 50-60Hz 0.15A (max.)
Charge indicator	No
Charge complete indicator	No

ACCESORIES

BUMPER (REFS.: BMP1000NOR / BMP2000)

Meet the BUMPER, the latest accessory for our automatic hooks.
The perfect absorber that protects your automatic hook from impacts, scratches and day-to-day wear.

Protect your hook and your load from scratches.
Protect workers in case of impact.
Extend product life.
Reduce maintenance costs.
Built from Polyurethane - PUR - (elastomeric).

evo5 to evo20 BUMPER



The evo5 to evo20 bumper can be retrofitted into older units and has a very simple installation. It is NOT valid for the evo2 automatic hook, ATEX hooks or hooks with counterbalance.

evo2 BUMPER



The evo2 bumper is not valid for other automatic hooks, ATEX hooks or hooks with counterbalance.

Safety lock that prevents battery from falling.

HEAT SHIELD (REF.: HS)

The standard automatic hook is rugged, designed and built to work in almost every industry, in any situation. There are though, special environments that require special measures, and in case of radiated heat and elevated temperatures, there's the Heat Shield.

The heat shield protects the automatic hook and its electronic components from radiated heat and extremely elevated temperatures.

It is highly recommended for operations where the automatic hooks are subject to extremely elevated temperatures and radiated heat, especially in the foundry industry.

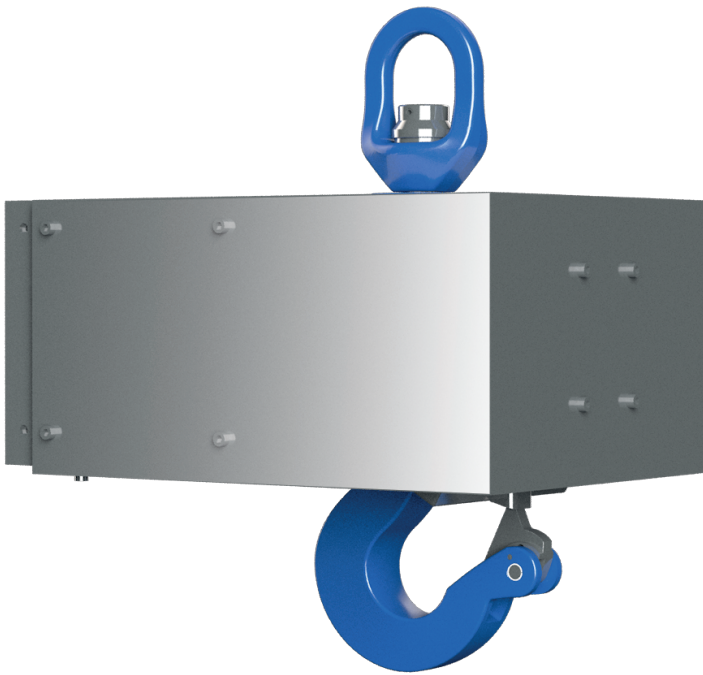

Made of ST 37-2 Steel
Galvanized surface treatment
Compatible with the complete range of automatic hooks (except evo2).
Approximate weight of 17 kg / 37.47 lb
Dimensions: 285 x 195 x 425 mm / 11.22 x 7.67 x 16.73 in

FLIP-UP BELT

The Flip-up Belt has been designed to carry and store the eMAX remote control. The eMAX remote control is protected while it is not being used and the operator can move freely.

When necessary, the operator simply flips up the eMAX remote control, adjusting its position and orientation to monitor its activity while keeping his hands free.



BIG BAG

elebia has reinvented the Big Bag to improve its safety and productivity. This new design, along with the automatic hook, allows to remotely pick and release Big Bags avoiding any kind of manipulation from the operator.

Instead of having the usual 4 corner loops, we've redesigned the traditional bulk bag to adapt it to our automatic hooks with two side handles and a central elebia sling which incorporates the metal wiring inside. This allows the automatic hook to attract and orient the central sling, needing just one unique lifting point to engage and elevate the load.

In addition, the elebia Big Bag allows you to easily load two bulk bags in each operation, increasing and enhancing your productivity. The elebia system is ideal for bulk material process plants, minimising handling from filling, internal transport, storage and dispatch.

The automatic hook and the especially redesigned and fitted elebia Big Bag allow for the manoeuvring operation to be a much faster, safer and comfortable experience.



Dimensions: 90 x 90 x 100 cm / 35.43 x 35.43 x 39.37 in
It can also be produced to meet customer specifications

FLIGHT CASE (REF.: FC evo5 / FC evo20)

Transport your automatic hooks and accessories anywhere you need safely and comfortably with the customised flight cases.

We have designed rigid boxes customised for each safety hook, with a protected interior and specific departments for different accessories.

Transportation will be simple and ergonomic thanks to its wheels and handle.



Dimensions FC evo5
485 x 185 x 170 mm /
19.09 x 7.28 x 6.69 in

Dimensions FC evo10/evo20
670 x 255 x 165 mm /
26.37 x 10.03 x 6.49 in

SWIVEL LOCK (REFS.: B5 / B10 / B20 / B25)

The swivel lock allows you to block the top swivel at any desired position. It is ideal for applications when a fixed orientation of the hook is desired or necessary.

Available for the complete range of automatic hooks (except evo2*)

* The swivel lock is a standard feature in the evo2 automatic hook

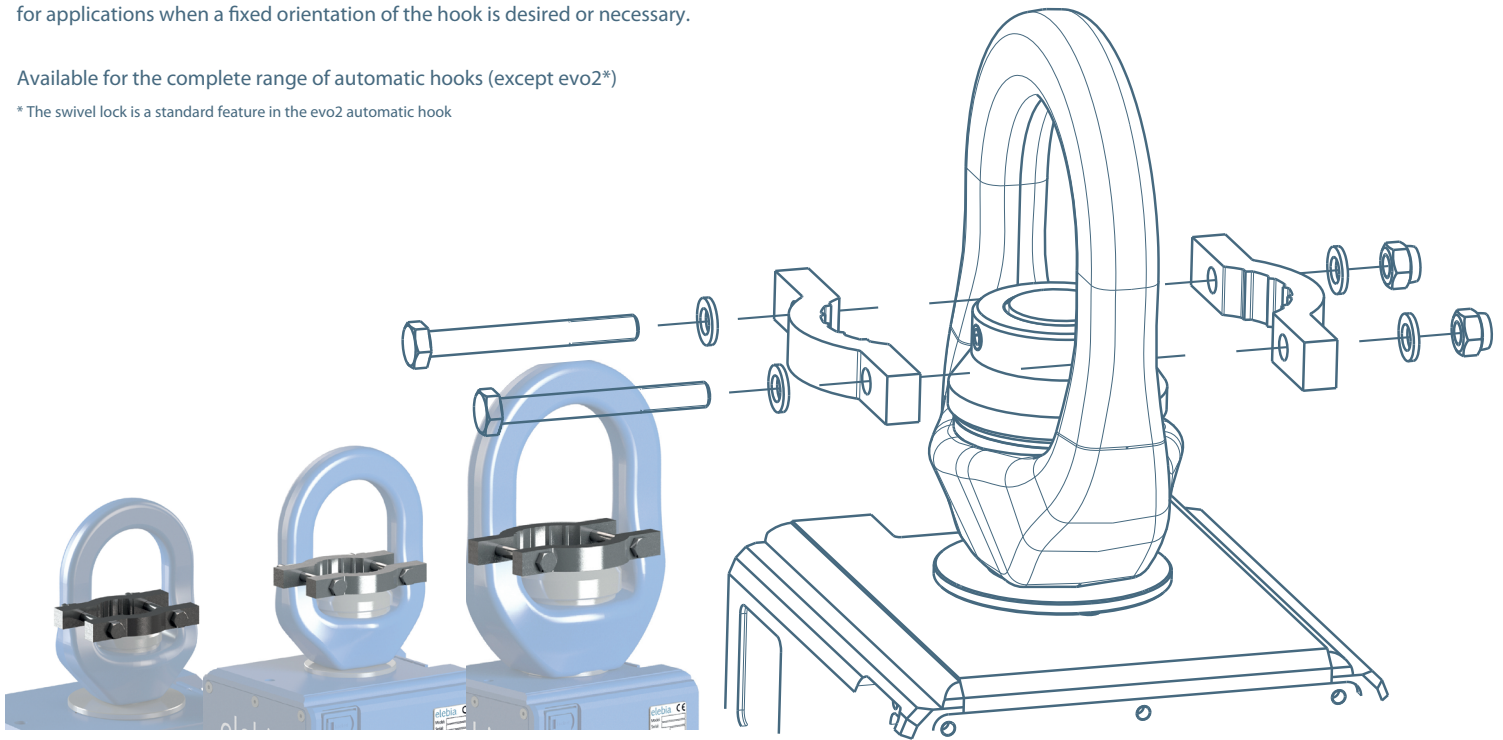

SLINGS

elebia slings are textile slings that incorporate a metal strip inside allowing the automatic hook to attract and orient the sling. The elebia slings are supplied on request. Manufactured in many lengths and capacities, to meet customer specifications.



TUBULAR SLING

Light and ultra-resistant nylon slings. This model is circular, with a wire rope running throughout the nylon-coated sling to ease engagement with the magnet of the elebia automatic hook. (Up to 3TN).



DOUBLE BAND SLING

Light and ultra-resistant nylon slings. The ends of this model are magnetized. A nylon-coated wire rope integrates the two sling handles to ease engagement with the magnet of the elebia automatic hook. (Up to 3TN).



BIG BAG SLING

Light and ultra-resistant nylon slings. The sling is designed to attach the two handles of the Big Bags and ease their remote engagement. A wire rope is placed in the centre of the nylon-coated sling to ease engagement with the magnet of the elebia automatic hook. (Up to 1TN).

evo2 TOP LINKS (REFS.: UCO8 / UMP8 / UMS16 / UMS18)

The system that links the evo 2 automatic lifting hook with the crane can be customized in order to adapt itself to any kind of situation.

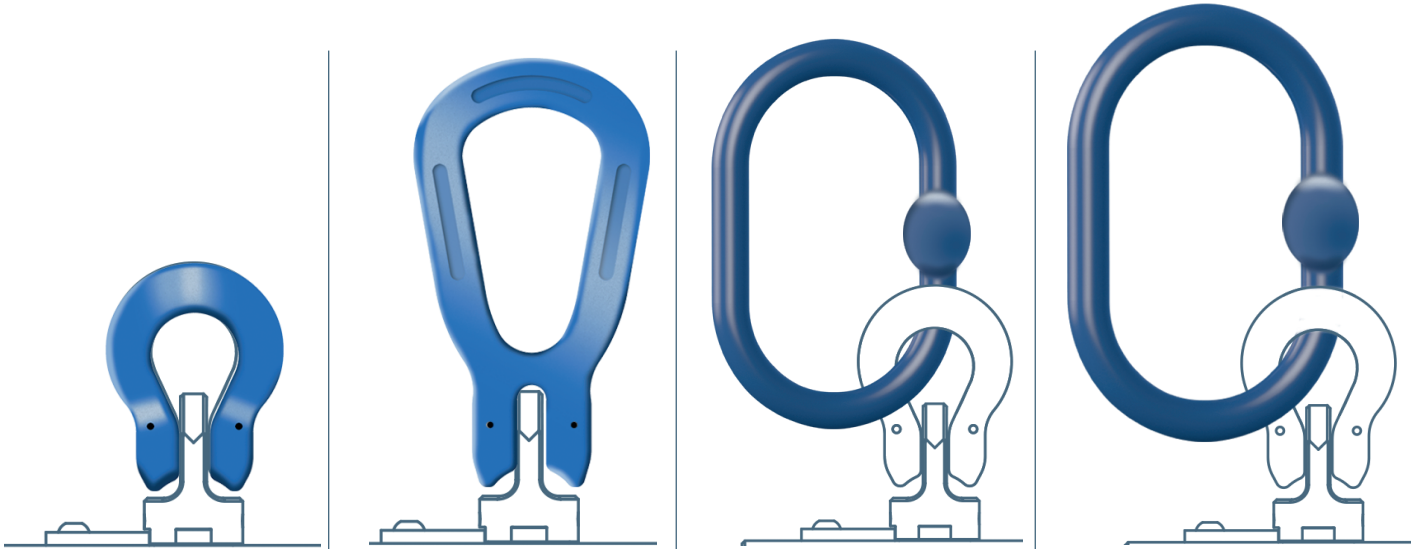

evo2 OMEGA SHACKLE

Alloy steel, grade10,
Quenched and Tempered
Safety factor: MBL = 4xWLL
Finish: Painted Blue
Certification: 2.1 / 2.2 / 3.1 / MPIb / DGUV

Size chart (mm / inches)

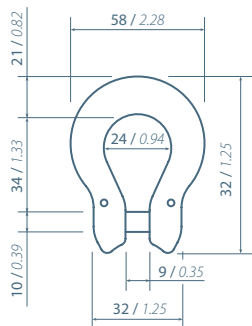

evo2 PEAR SHACKLE

Alloy steel, grade10,
Quenched and Tempered
Safety factor: MBL = 4xWLL
Finish: Painted Blue
Certification: 2.1 / 2.2 / 3.1 / MPIb

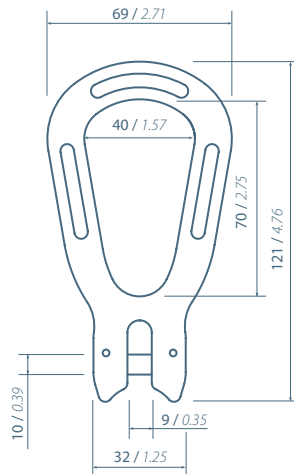

evo2 OMEGA SHACKLE + MASTERLINK 3.15

Alloy steel, grade10,
Quenched and Tempered
Safety factor: MBL = 4xWLL
Finish: Painted Blue
Certification: 2.1 / 2.2 / 3.1 / MTCb

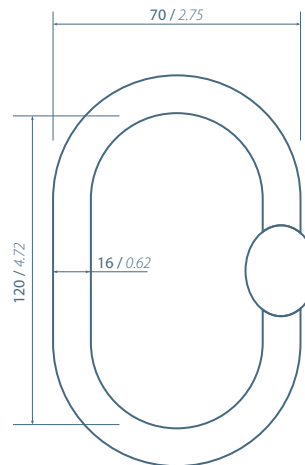

evo2 OMEGA SHACKLE + MASTERLINK 5.4

Alloy steel, grade10,
Quenched and Tempered
Safety factor: MBL = 4xWLL
Finish: Painted Blue
Certification: 2.1 / 2.2 / 3.1 / MPIC

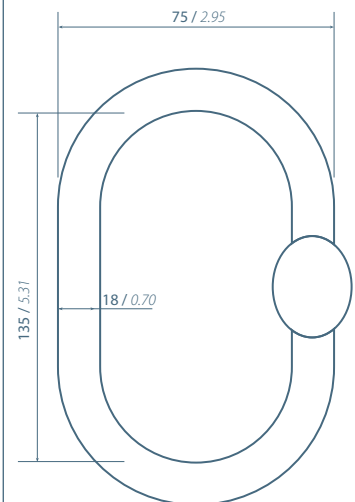

HOOK CONFIGURATOR

Visit our online configurator at www.elebia.com/configurator

HOOK MODEL

evo2

2,500 kg / 5,511 lb

--	Ω	P2	ML3.15	ML5.4
	REF.: OPTION UCO8	REF.: OPTION UMP8	REF.: OPTION UMS16	REF.: OPTION UMS18

evo5

5,000 kg / 11,023 lb

--	B10	B20	L5
	REF.: OPTION B10	REF.: OPTION B20	REF.: OPTION L5

evo10c

10,000 kg / 22,046 lb

--	B20	L10
	REF.: OPTION B20	REF.: OPTION L10

evo10

10,000 kg / 22,046 lb

--	B20	L10
	REF.: OPTION B20	REF.: OPTION L10

evo20

20,000 kg
44,092 lb

--	L20
	REF.: OPTION L20



evo25

25,000 kg
55,115 lb

--	L25
	REF.: OPTION L25

MAGNETIC SYSTEM

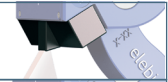
	POWER MAGNET & RIGID SAFETY LATCH 	
	POWER MAGNET 	









	MAGNET SENSOR	
	VOID, NO MAGNET	





LOAD CELL

	evo5 - evo25	
--	---------------------	---

	evo2	
--	-------------	---

TOP LINK

	B10 	
	B20 	
	L5 	
	L10 	
	L20 	
	L25 	



	Ω	
	P2	
	ML3.15	
	ML5.4	

SPECIAL ENVIRONMENTS

	HEAT SHIELD 	
	DNV 	









	ATEX / IECEx 	
	MARINE	







REMOTE CONTROLS

	eMAX	
	eMINI	

	INSTALLABLE 24 V	
	INSTALLABLE 48 V	

BATTERY / CHARGERS

	BATTERY evo5 - evo25 	
	220V CHARGER evo5 - evo25 	
<input type="checkbox"/>	Cord EU	<input type="checkbox"/>
<input type="checkbox"/>	Cord UK	<input type="checkbox"/>
<input type="checkbox"/>	Cord USA	<input type="checkbox"/>
	24V CHARGER evo5 - evo25 	
	MULTIPLE CHARGER evo5 - evo25 	

	BATTERY evo2 	
	220V CHARGER evo2 	
<input type="checkbox"/>	Cord EU	<input type="checkbox"/>
<input type="checkbox"/>	Cord UK	<input type="checkbox"/>
<input type="checkbox"/>	Cord USA	<input type="checkbox"/>
	MULTIPLE CHARGER evo2 	

ACCESSORIES

	BUMPER evo5 - evo20  	
	HEAT SHIELD evo5 - evo25 	
	SWIVEL LOCK evo5 - evo25 	
	FLIGHT CASE evo5 - evo20  	
<input type="checkbox"/>	evo5	<input type="checkbox"/>
<input type="checkbox"/>	evo10-evo20	<input type="checkbox"/>

	BUMPER evo2 	
	FLIP-UP BELT	
	BIG BAGS	
	SLINGS	
<input type="checkbox"/>	TUBULAR	<input type="checkbox"/>
<input type="checkbox"/>	DOUBLE BAND	<input type="checkbox"/>
<input type="checkbox"/>	BIG BAG	<input type="checkbox"/>



elebia collaborates with WeForest
in reversing deforestation



elebia®

Plaça Pere Llauger Prim, Naus 10-11 · Polígon Industrial Can Misser
08360 Canet de Mar (Barcelona) Spain

www.elebia.com